



## Water Depth Effect to Ferry Ship Resistance with Computational Fluid Dynamic Method

Khairuddin<sup>1,\*</sup>, Andi Haris Muhammad<sup>1</sup>, Muhammad Iqbal Nikmatullah<sup>1</sup>, Faisal Mahmuddin<sup>1</sup>

<sup>1</sup> Marine Engineering Department, Faculty of Engineering, Hasanuddin University, Indonesia

### ARTICLE INFO

#### Article history:

Received 24 March 2022

Received in revised form 26 May 2022

Accepted 27 May 2022

Available online 31 May 2022

#### Keywords:

Ferry Ship; Resistance; Deep Water;  
Medium Water; Shallow Water

### ABSTRACT

Predicting ship resistance in shallow water conditions is very important for the operational considerations of a ship. Shallow waters greatly affect viscous resistance, wave resistance and also propulsion efficiency. This study aims to determine the effect of water depth on the resistance of the ferry. The CFD method was used to simulate this phenomenon and its effects on the hull starting from the coefficient of ship resistance, surge force, sway force and yaw (hydrodynamic moment). Input speed at 9 – 13 knots with depth ratio  $H/T = 4$  (deep water),  $H/T = 3$  (deep water),  $H/T = 2$  (medium water),  $H/T = 1.3$  (shallow water), and  $H/T = 1$  (very shallow water). The simulation results show a significant increase in total resistance, surge force, sway force, and hydrodynamic moment in shallow water conditions in every speed variation. This condition is caused by the increase in pressure received by the ship's hull when operating in shallow water.

## 1. Preliminary

The different geographical forms in each water area in Indonesia are the background causing the different depths in each shipping lane. In addition, changes in the usual depth also often occur over time due to the presence of deposits and increased sedimentation processes in these water areas. The depth of the shipping lane is also very important because it is a consideration for the operation of a ship, so it is not uncommon for a dredger to increase the depth of a shipping lane or a port where the ship rests to support the smooth operation of ships in the area. A ferry is a ship that meets the requirements of sailing at sea and is used to carry out permanent transportation, for example between islands. The important role of ferries in the inter-island passenger and vehicle transportation sector has caused the ship to become one of the important sectors. Studies and innovations related to ferries must continue to be carried out in order to produce an optimal transportation system both in terms of design and operation. At the design stage, the thing that needs to be considered in the calculation of the ship's resistance will then greatly affect the ship's propulsion system.

\* Corresponding author.

E-mail address: [khairuddinms98@gmail.com](mailto:khairuddinms98@gmail.com) (Khairuddin)

<https://doi.org/10.37934/cfdl.14.5.98105>

Predicting ship resistance in shallow water conditions is very important for ship propulsion system design considerations [1, 2]. Shallow waters greatly affect viscous resistance and wave resistance, and propulsion efficiency. Ship resistance in shallow water is much greater than in deep water [3, 4].

## 2. Methodology

### 2.1 Ship Data

In this study, using the Ferry Ro-Ro ship KMP Bontoharu 1050 GT with a main engine power of 2 x 1000 HP for the route from Bira port, Bulukumba district to Pamatata port, Selayar district with the following data (see Figure 1 and Table 1):

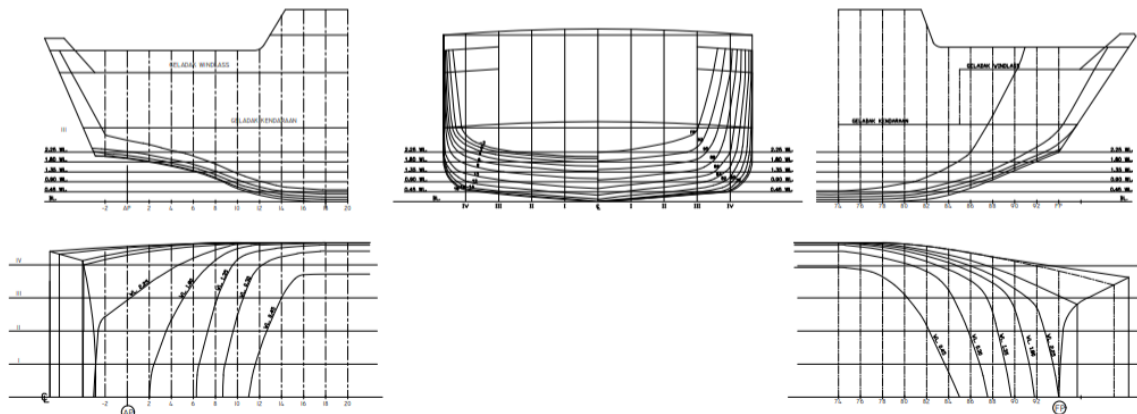

**Fig. 1.** Lines Plan of KMP. Bontoharu 1050 GT

**Table 1**  
 Ship Data

Main Size	Unit	Number
Overall Length (LOA)	m	54.00
Perpendicular Length (LBP)	m	47.45
Wide	m	14.00
Tall	m	3.40
Loaded	m	2.45
Speed	m/s	6.618
Displacement	Ton	1148
Cb	-	0.72
Cp	-	0.73
Cm	-	0.98
Cw	-	0.82

### 2.2 Ship Modeling

Modeling the ship KMP Bontoharu as the main object in this research is to use the Maxsurf Modeler application. The input image is in the form of a lines plan which is then made 3D modeling. After that, the designed model is exported in Iges or Step files to facilitate CFD application in model execution and setup.

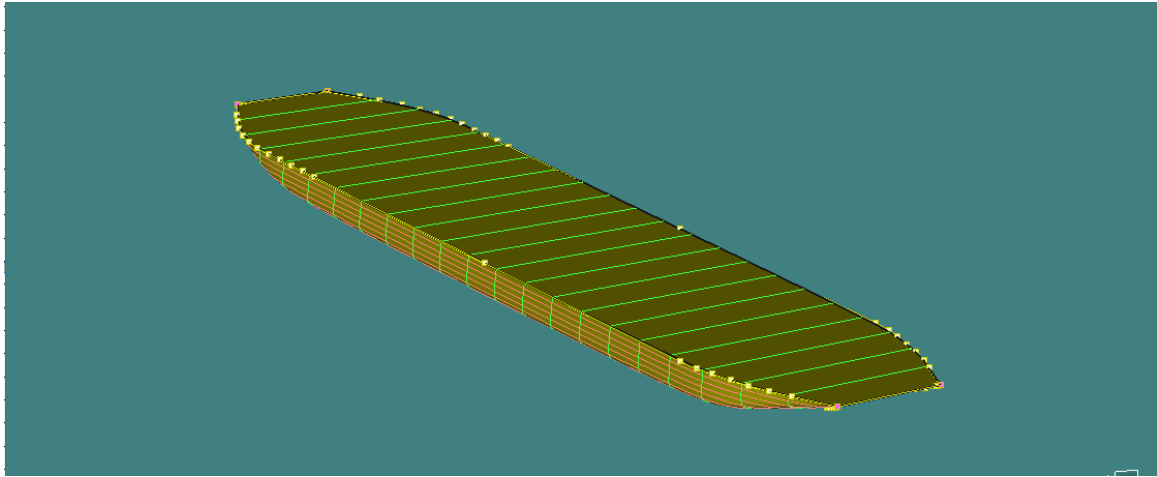
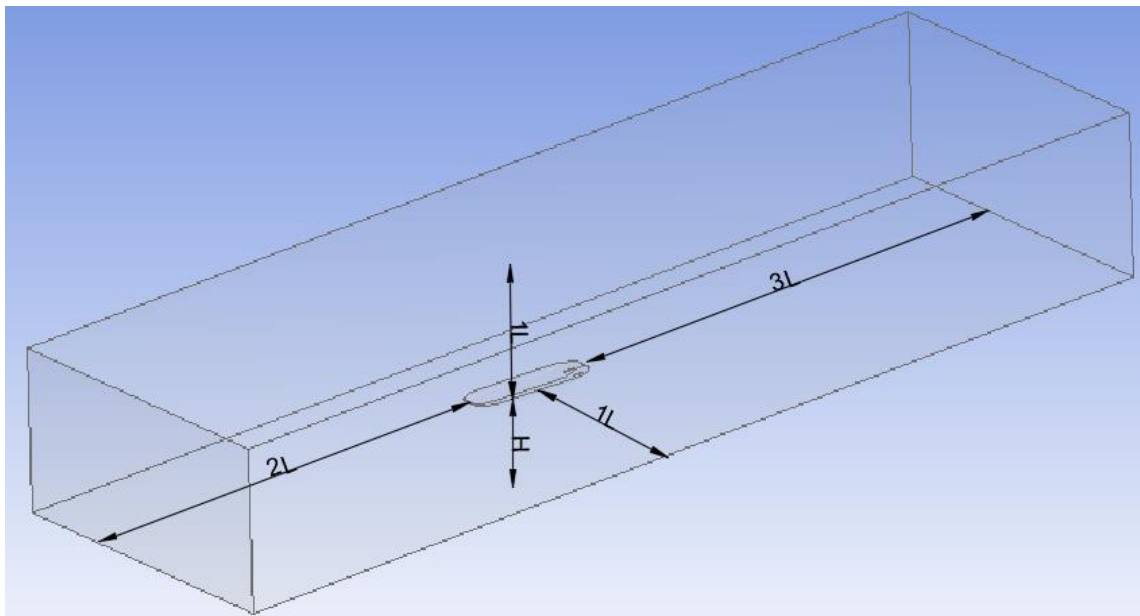

**Fig. 2.** KMP Bontoharu Hull Model on Maxsurf Modeler

Figure 2 presented the surface of the Bontoharu ship which was designed with a ship's draft of 2.45 m. Grid design that can be conditioned as needed to make it easier to calculate and divide tusks (frames), waterlines (waterlines), buttock lines, and others.

### 2.3 CFD Setup

In testing the model using the Computational Fluid Dynamic method by using several predetermined parameters. Using this method which has high efficiency, is more economical, and takes less time with accurate results [5, 6]. By using the Ansys software version R18.1 boundary conditions can be set so that the water depth can be simulated in this software. The following is the setting of the boundary conditions in this software [7, 8] (see Figure 3).



**Fig. 3.** Boundary Conditions

After determining the simulation boundary conditions (fluid domain) in the simulation, the next step is to divide the geometry into several small parts (meshing). By dividing by a triangle shape as shown in Figure 4.

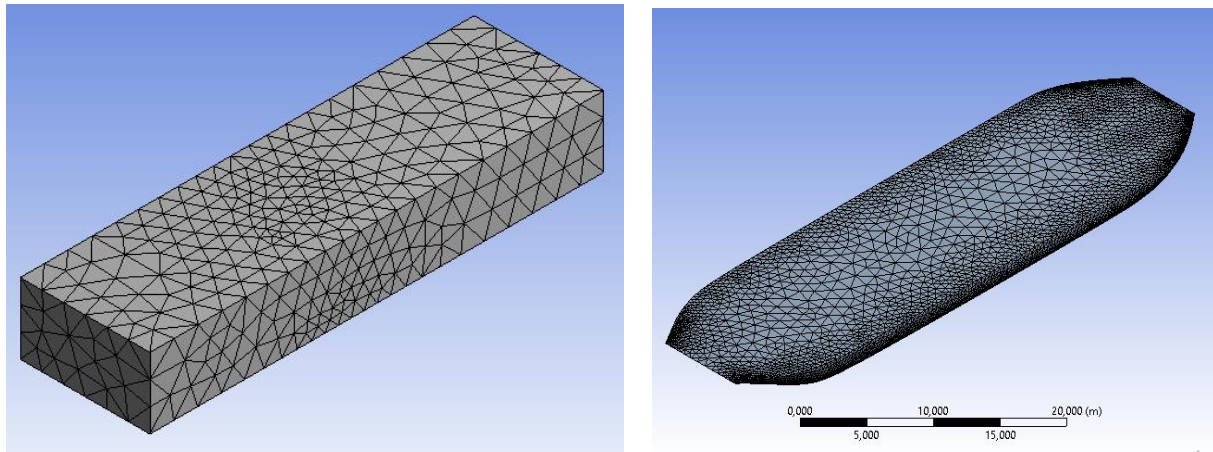

(a) (b)  
**Fig. 4.** (a) Hull Meshing (b) Meshing with Fluid Domain

Figure 4(a) is the view of the KMP Bontoharu 1050 GT ferry hull meshing with a tighter mesh appearance on the arch and sides of the ship. While figure 4(b) is the meshing of the ship's hull with a fluid domain. From the above view, the middle condition of the fluid domain has a smaller and tighter meshing appearance because at that position the hull is located. By using SST turbulent flow and some test parameters as shown in Table 2.

**Table 2**  
 Simulation Parameters

Parameter	
v(m/s)	6.618
H/N	4, 2, 1.3

#### 2.4 Data Analysis

Figure 5 shows the system ordinate.

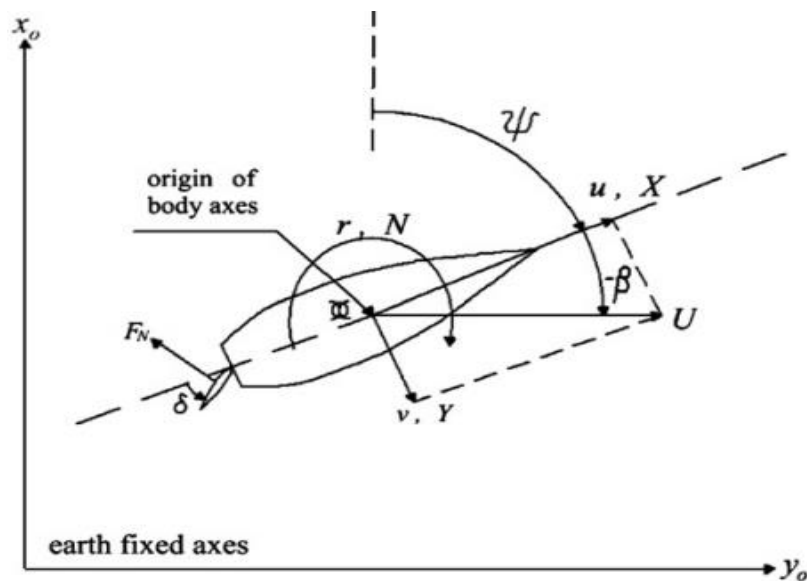

**Fig. 5.** System Ordinate

Analysis of CFD simulation results using the following formula [9, 10]:

$$\frac{[R'_0]_{\text{shallow}}}{[R'_0]_{\text{deep}}} = 0.388(N/H)^2 + 1 \quad (1)$$

$$X'_H, Y'_H = \frac{X'_H, Y'_H}{\frac{1}{2}\rho L p p d U^2} \quad (2)$$

$$N'_H = \frac{X'_H, Y'_H}{\frac{1}{2}\rho L p p^2 d U^2} \quad (3)$$

### 3. Results and Discussion

A comparison is needed to find out the simulation results that are accurate and can be accounted for by using other methods as an approach. Figure 6 shows a comparison between the simulation results using the Ansys Fluent R18.1 software using the Maxsurf Resistance software. The resistance of the ship will increase as the ship's speed increases. In Figure 6, it is shown that the largest percentage is -8.59%, namely at a speed of 10 knots with a comparison value of 38,787 N on CFD with 42,431 N on Holtrop Maxsurf Resistance. The simulation results of the largest resistance occurred at a speed of 13 knots, which was 101,355 N on CFD and 106,125 N on Holtrop, and the smallest resistance simulation results occur at a speed of 9 knots that is equal to 31,427 N on CFD and 32,150 N on Holtrop simulation. This difference occurs because the resistance calculation method used in the Maxsurf is different from Ansys. However, with a difference that is below 10%, it can be said that the calculation of ship resistance using Ansys software can be used for further calculations in this study.

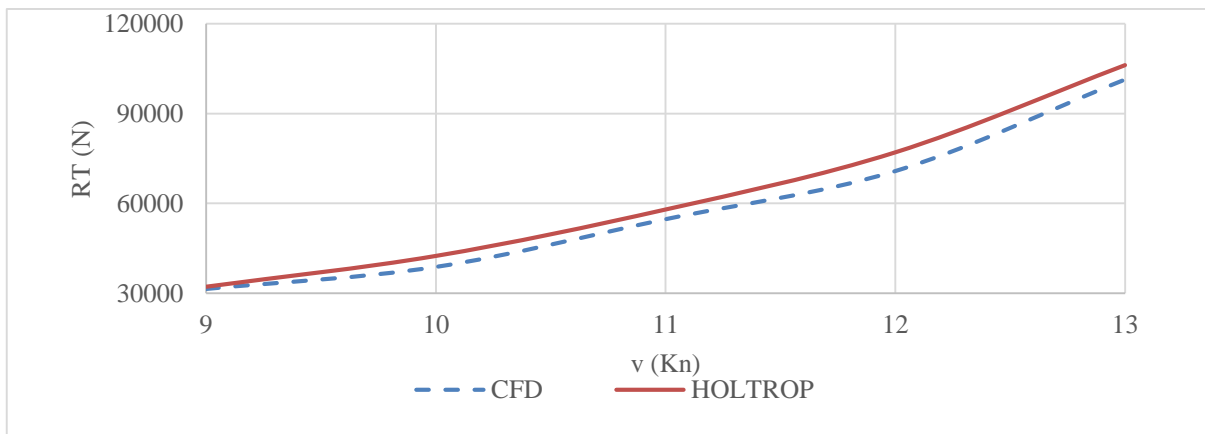

Fig. 6. Comparison of CFD Ship Resistance with Holtrop

While Figure 7 shows the simulation results of ship resistance using Ansys R18.1 software. The simulation is carried out using the service speed of the KMP ship. Bontoharu, which is 6.618 m/s, is also carried out with several water depth conditions, H/T 4 (deep water), H/T 2 (medium water), and H/T 1.3 (shallow water). The following graph shows the results of the simulation of resistance with variations in water depth.

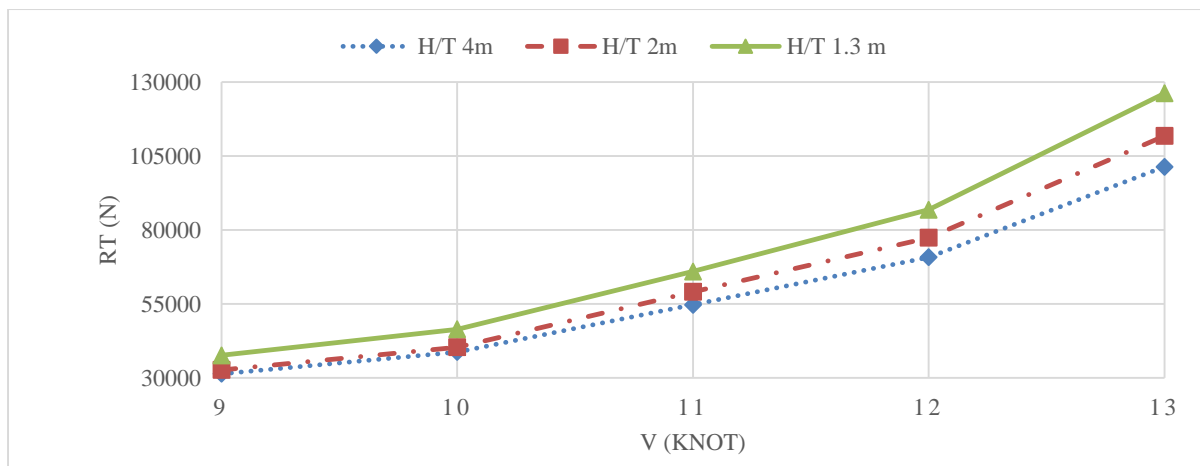

Fig. 7. KMP Bontoharu Ship Resistance with Depth Variation

Based on the Figure 7 above, it can be seen that the ship's resistance in shallow water is greater than in medium and deep water. This is due to the large waves generated by the ship which affect the frictional resistance on the sides of the ship, this is in line with the results of the analysis conducted by Cai *et al.*, [11] and Caplier *et al.*, [12].

Figure 8 shows graph of X'H Simulation Results with Variations in Depth.

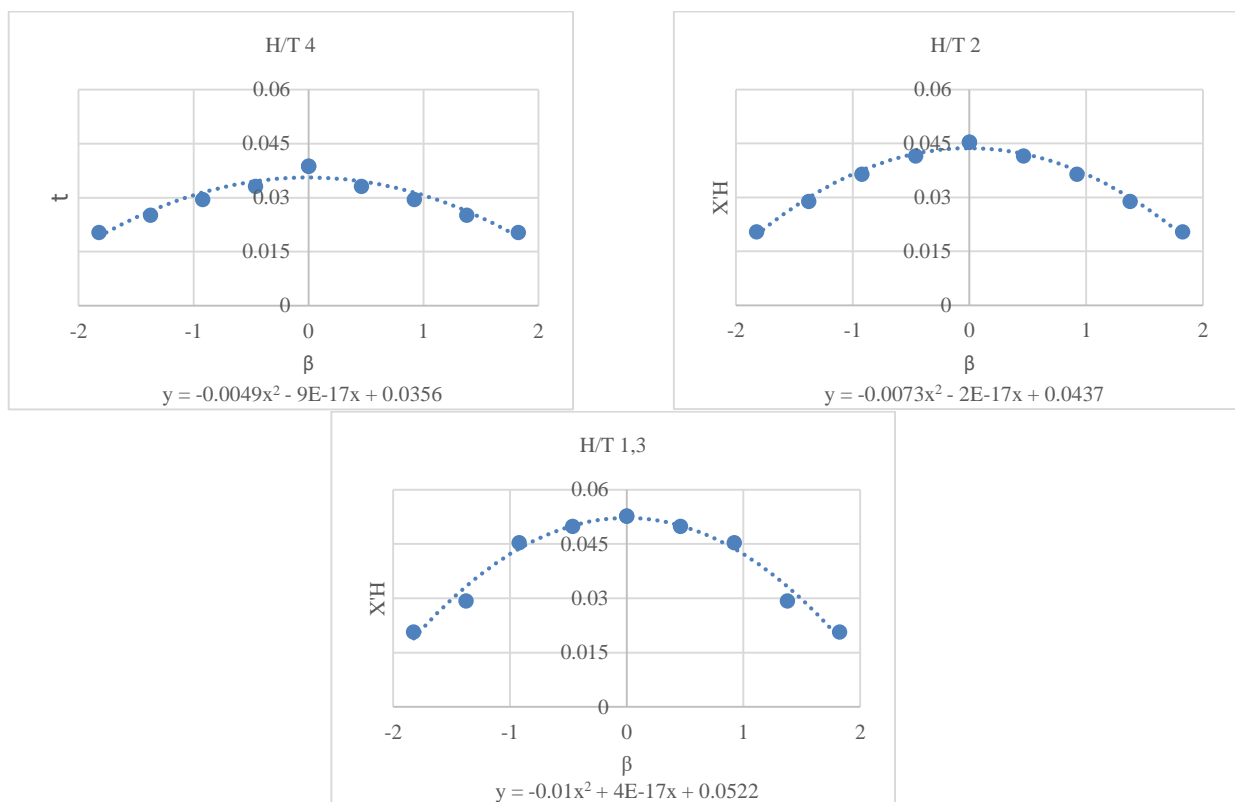
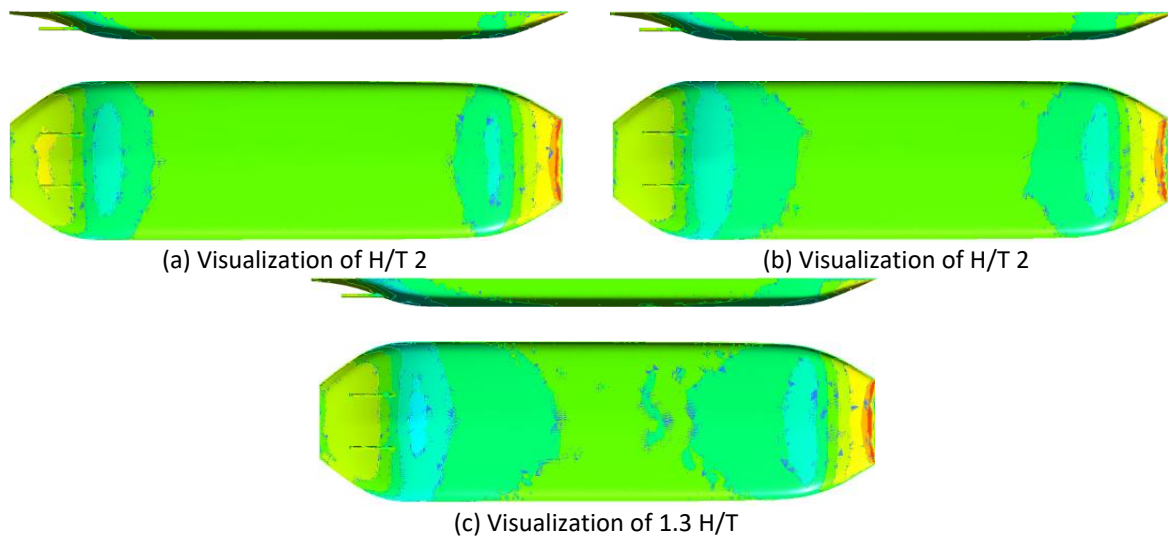

Fig. 8. Graph of X'H Simulation Results, with Variations in Depth

Based on Kijima's formula, function number 1 can be described as follows [13]:

- i. The comparison between the resistance in shallow water and deep water conditions is 1.360 and Kijima's empirical results are 1.23.
- ii. Therefore, the percentage of error is 10.6%.



**Fig. 9.** Pressure Characteristics from CFD Simulation

From the results of the simulation carried out on the Ansys R18.1 software, it has been shown the results of the visualization of the pressure on the KMP Bontoharu Ferry hull (see Figure 9). It can be seen that the pressure distribution around the hull increases as the water depth gets shallower [14]. This causes a pressure difference in the hull so that the ship's resistance increases in shallow water.

#### 4. Conclusion

Based on the research above, it can be concluded as follows:

- i. As the speed of the ship increases, the resistance of the ferry will increase. The graph shows that the smallest resistance value is at a speed of 9 knots, which is 31427 N on D/T 4; 32721 N on D/T 2; 37655 N at D/D 1.3. The graph shows that the largest resistance value is at a speed of 13 knots, which is 101355 N at D/T 4; 111806 N at D/D 2; 126234 N at 1.3 D/D.
- ii. In this study, the depth of the water affects the ship's resistance, the shallower the ship's resistance will increase due to the different pressure distribution at each depth difference.
- iii. The ship's speed increases, the ship's resistance will also increase.

#### References

- [1] Kristensen, Hans Otto, and Marie Lützen. "Prediction of resistance and propulsion power of ships." *Clean Shipping Currents* 1, no. 6 (2012): 1-52.
- [2] Suastika, Ketut, Gilbert Ebenezer Nadapdap, Muhammad Hafiz Nurwahyu Aliffrananda, Yuda Apri Hermawan, I. Ketut Aria Pria Utama, and Wasis Dwi Aryawan. "Resistance Analysis of a Hydrofoil Supported Watercraft (Hysuwac): A Case Study." *CFD Letters* 14, no. 1 (2022): 87-98. <https://doi.org/10.37934/cfdl.14.1.8798>
- [3] Pacuraru, F., and L. Domnisoru. "Numerical investigation of shallow water effect on a barge ship resistance." In *IOP Conference Series: Materials Science and Engineering*, vol. 227, no. 1, p. 012088. IOP Publishing, 2017. <https://doi.org/10.1088/1757-899X/227/1/012088>
- [4] Rotteveel, E., and R. G. Hekkenberg. "The influence of shallow water and hull form variations on inland ship resistance." In *IMDC 2015: Proceedings of the 12th International Marine Design Conference, Tokyo, Japan, 11-14 May 2015*. 2015.

- [5] Ammar, Nader R., Mohamed M. Elgohary, Akram Zeid, and Ahmed G. Elkafas. "Prediction of shallow water resistance for a new ship model using CFD simulation: case study container barge." *Journal of Ship Production and Design* 35, no. 02 (2019): 198-206.
- [6] Zeng, Q., R. Hekkenberg, C. Thill, and E. Rotteveel. "A numerical and experimental study of resistance, trim and sinkage of an inland ship model in extremely shallow water." In *Proceedings of the International Conference on Computer Applications in Shipbuilding, Singapore*, pp. 26-28. 2017.
- [7] RoyChoudhury, Seemontini, Anil Kumar Dash, Vishwanath Nagarajan, and Om Prakash Sha. "CFD simulations of steady drift and yaw motions in deep and shallow water." *Ocean engineering* 142 (2017): 161-184. <https://doi.org/10.1016/j.oceaneng.2017.06.058>
- [8] Nabawi, Rahmat Azis. "Study Reduction of Resistance on The Flat Hull Ship of The Semi-Trimaran Model: Hull Vane Vs Stern Foil." *CFD Letters* 13, no. 12 (2021): 32-44. <https://doi.org/10.37934/cfdl.13.12.3244>
- [9] Maimun, A., A. Priyanto, A. H. Muhammad, C. C. Scully, and Z. I. Awal. "Manoeuvring prediction of pusher barge in deep and shallow water." *Ocean Engineering* 38, no. 11-12 (2011): 1291-1299. <https://doi.org/10.1016/j.oceaneng.2011.05.011>
- [10] Muhammad, A. H., D. Paroka, S. Rahman, M. R. Firmansyah, and T. P. Putra. "Characteristics of Turning Circle and Zig-Zag Manoeuvres of An Indonesian Ferry Ship In Shallow Water." In *IOP Conference Series: Materials Science and Engineering*, vol. 1052, no. 1, p. 012036. IOP Publishing, 2021. <https://doi.org/10.1088/1757-899X/1052/1/012036>
- [11] Cai, Chuang, Xinyong Cai, and Yi Li. "Model tests for shallow-water ship maneuverability in Three Gorges Reservoir." *Polish Maritime Research* (2015). <https://doi.org/10.1515/pomr-2015-0045>
- [12] Caplier, Clément, Germain Rousseaux, Damien Callaud, and Laurent David. "Energy distribution in shallow water ship wakes from a spectral analysis of the wave field." *Physics of Fluids* 28, no. 10 (2016): 107104. <https://doi.org/10.1063/1.4964923>
- [13] Furukawa, Yoshitaka, H. Ibaragi, Y. Nakiri, and K. Kijima. "Shallow water effects on longitudinal components of hydrodynamic derivatives." In *4th MASHCON-International Conference on Ship Manoeuvring in Shallow and Confined Water with Special Focus on Ship Bottom Interaction*, pp. 295-303. 2016.
- [14] Mujahid, Ahmad Syafiul. "Prediksi Hambatan Kapal Ferry Ro-Ro 750 GT Berbasis Pengujian Hidrodinamika." *REM (Rekayasa Energi Manufaktur) Jurnal* 3, no. 2 (2019): 51-56.